

Sehpa ve Stand Profilleri

Stand Profiles

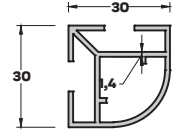

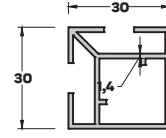
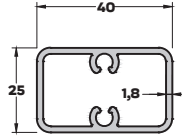
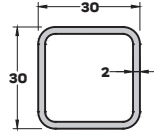
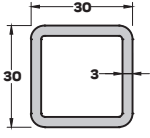

ST-2094 (0,840 kg/mt)

ST-2095 (0,567 kg/mt)

ST-2163 (0,697 kg/mt)

ST-2333 (0,566 kg/mt)

ST-2334 (0,540 kg/mt)

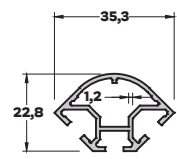
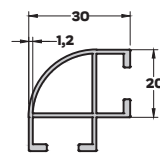
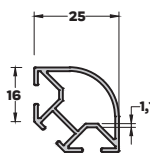
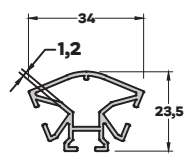
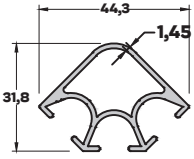

ST-2880 (0,594 kg/mt)

ST-317 (0,430 kg/mt)

ST-192 (0,352 kg/mt)

ST-200 (0,352 kg/mt)

ST-2557 (0,393 kg/mt)

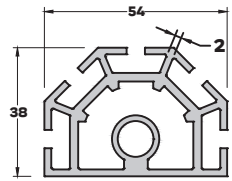
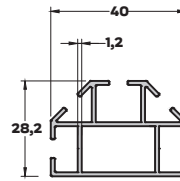
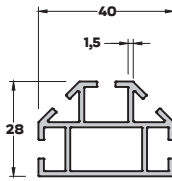
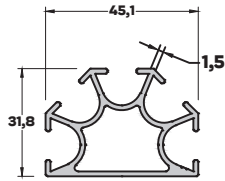
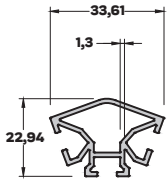

ST-4612 (0,445 kg/mt)

ST-2882 (0,780 kg/mt)

ST-4613 (0,710 kg/mt)

ST-4312 (0,577 kg/mt)

ST-2588 (1,666 kg/mt)

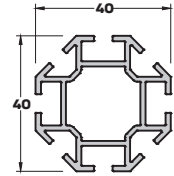
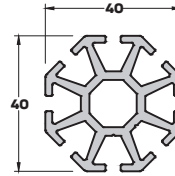
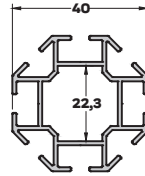
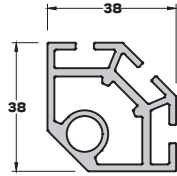
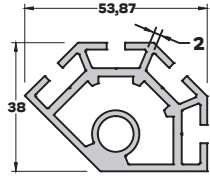

ST-2697 (1,504 kg/mt)

ST-2777 (1,210 kg/mt)

ST-311 (0,733 kg/mt)

ST-2472 (1,361 kg/mt)

ST-4614 (0,902 kg/mt)

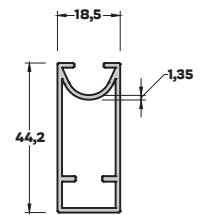
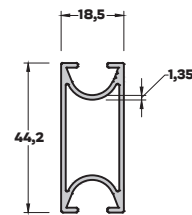
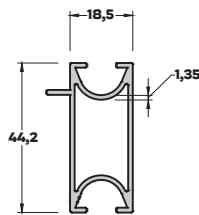
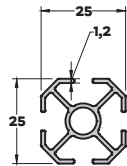
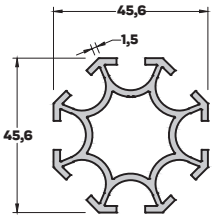

ST-2697 (1,504 kg/mt)

ST-313 (0,399 kg/mt)

ST-2881 (0,578 kg/mt)

ST-2879 (0,554 kg/mt)

ST-2879 (0,524 kg/mt)

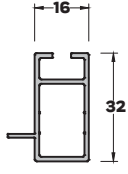

ST-4611 (0,351 kg/mt)

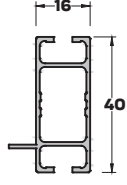

ST-2556 (0,427 kg/mt)

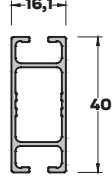

ST-4629 (0,428 kg/mt)

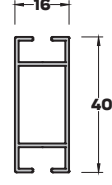

ST-315 (0,370 kg/mt)

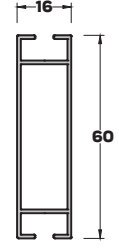

ST-316 (0,489 kg/mt)

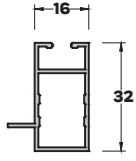

ST-121 (0,334 kg/mt)

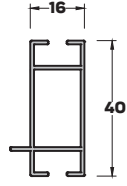

ST-139 (0,391 kg/mt)

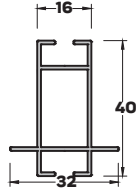

ST-134 (0,409 kg/mt)

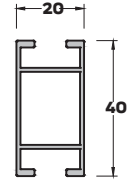

ST-99 (0,464 kg/mt)

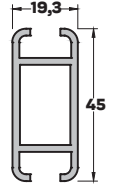

ST-4934 (0,718 kg/mt)

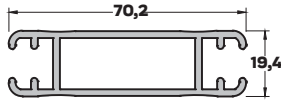

ST-4307 (1,024 kg/mt)

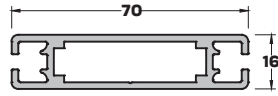

ST-2474 (1,050 kg/mt)

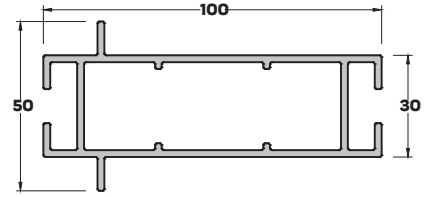

ST-4899 (1,649 kg/mt)

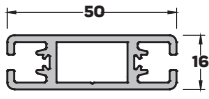

ST-2473 (0,837 kg/mt)

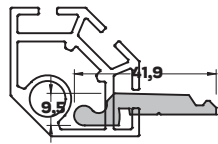

ST-4167 (0,596 kg/mt)

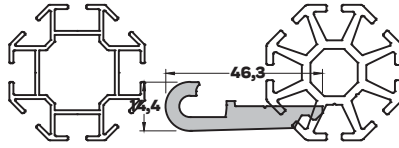

ST-4168 (0,765 kg/mt)

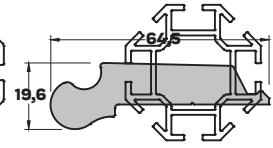

ST-4873 (1,649 kg/mt)

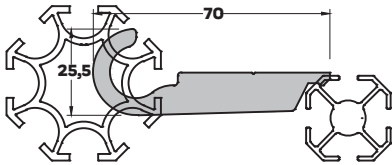

ST-2473 (0,837 kg/mt)

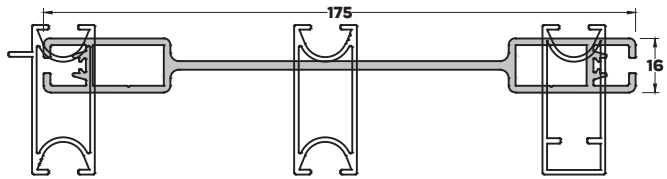

ST-2475 (1,896 kg/mt)

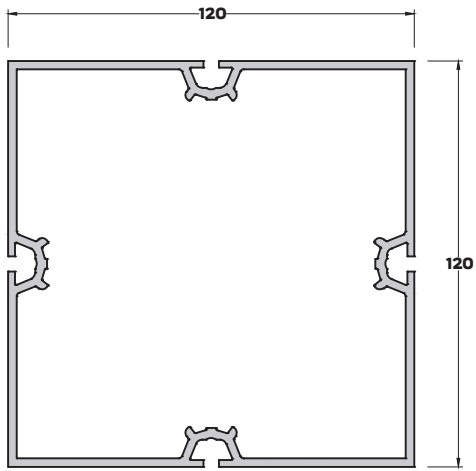

ST-3861 (3,778 kg/mt.)

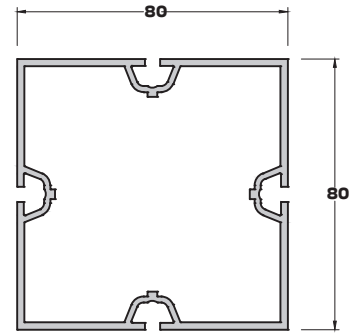

ST-4496 (2,167 kg/mt.)

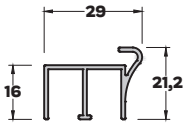

ST-4657 (0,287 kg/mt.)

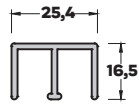

ST-177 (0,327 kg/mt.)

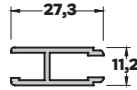

ST-5091 (0,269 kg/mt.)

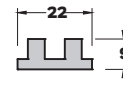

ST-1269 (0,340 kg/mt.)

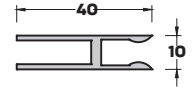

ST-155 (0,372 kg/mt.)